

*JUST LIKE
CLOUD 7.*
CL 910.



Your CLASSICS-advantages

CL 910

Blending comfortable versatility with a floating character, this elegant sofa boasts a dramatic quality. Captivating with its seam-free seat and back cushion, the seating furniture offers true comfort. The skids continue the narrow lines of the armrests in typical style.

- ▶ 5 seat qualities
- ▶ 3 back cushion upholsteries
- ▶ 3 seat depths: 53 cm, 58 cm and 62 cm
- ▶ 2 different seat heights: 43 cm and 46 cm



Take your Smartphone,
scan the QR-Code and
experience the CL 910.

CLASSICS

erpo[®]
Sitz. Kultur.

CL 910



Aufbau / Construction / Rembourrage / Opbouw

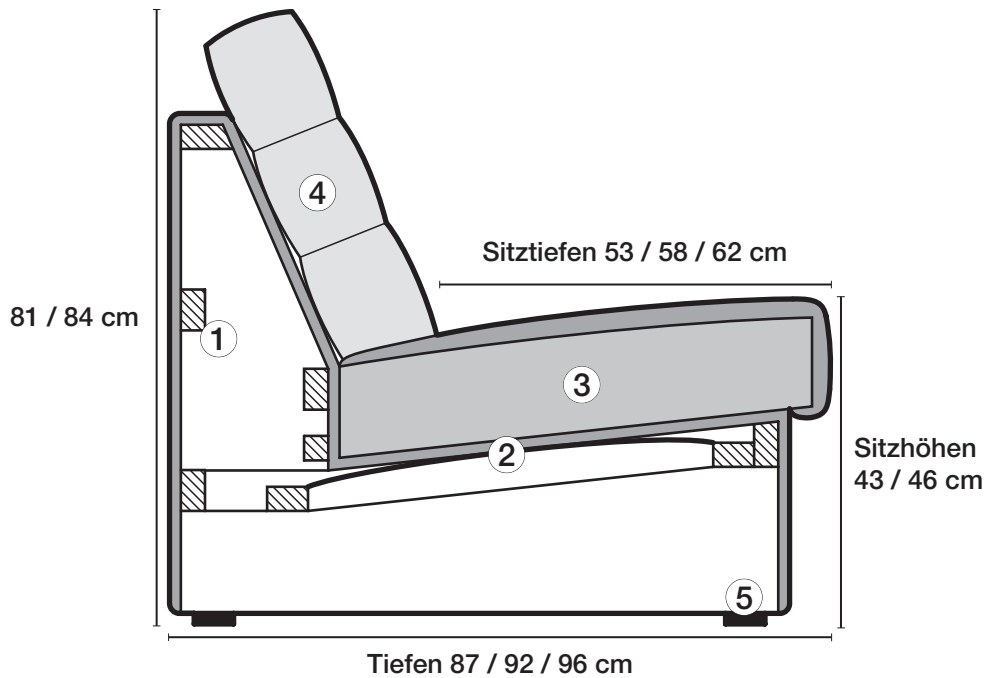

1 Gestell
Hartholzgestell aus Buche, gedübelt und verleimt.

2 Unterfederung
Stahlwellenunterfederung mit Spezialabdeckung aus hochwertigem Futterstoff.

3 Sitzkissen
Daunencharakter
Comfort SL
Kaltschaumkombination
Taschenfederkern
Comfort Plus

4 Rückenkissen
Daunencharakter
Comfort SL
Kaltschaumkombination

Sitztiefen
Sitztiefe 53 cm
Sitztiefe 58 cm
Sitztiefe 62 cm

Sitzhöhen
Sitzhöhe 43 cm
Sitzhöhe 46 cm
Sonderhöhen möglich

5 Fussausführungen
Kunststoffgleiter 9 mm

1 Frame
Hardwood frame in beech, plugged and glued.

2 Spring base
Steel corrugated spring base with special covering made of high-quality lining material.

3 Seat cushions
Downy character
Comfort SL
Foam combination
Pocket spring core
Comfort Plus

4 Back cushions
Downy character
Comfort SL
Foam combination

Seat depths
Seat depth 53 cm
Seat depth 58 cm
Seat depth 62 cm

Seat heights
Seat height 43 cm
Seat height 46 cm
Special heights possible

5 Legs
Plastic sliding glider 9 mm

1 Châssis
Solide châssis en hêtre, chevillé et collé.

2 Suspension
Ressorts métalliques ondulés avec revêtement spécial.

3 Coussins de siège
Type duvet
Comfort SL
Combinaison polyéther et mousse à froid
Ressorts ensachés
Comfort Plus

4 Coussins de dossier
Type duvet
Comfort SL
Combinaison polyéther et mousse à froid

Profondeurs d'assise
53 cm
58 cm
62 cm

Hauteur de siège
43 cm
46 cm
Hauteurs spéciales possible

5 Modèles de pied
Patin en matière plastique 9 mm

1 Frame
Frame uit beuk, geplugd en vastgelijmd.

2 Vering
Stalen springveren met speciale afwerking.

3 Zitkussens
Donskarakter
Comfort SL
Koudschuimcombinatie
Kern van pocketveren
Comfort Plus

4 Rugkussens
Donskarakter
Comfort SL
Koudschuimcombinatie

Zitdiepte
53 cm
58 cm
62 cm

Zithoogte
43 cm
46 cm
Speciale hoogten mogelijk

5 Voetuitvoeringen
Plastic glijder 9 mm

Produktinformation / Product information Informations produits / Productinformatie

Gestell Hartholzgestell aus Buche, gedübelt und verleimt.

Unterfederung Stahlwellenunterfederung mit Spezialabdeckung und hochwertigem Futterstoff.

- Sitzkissen**
- A Daunencharakter**
Legere Ausführung in bewährter Kammerkissen-Verarbeitung und stabilisierendem Sitzkern aus Polyetherschaum RG 43. Füllung Polyschaumstäbchen mit hochwertigen Vliesfasern.
- B Comfort SL**
Weiche besonders anpassungsfähige Ausführung mit stabilisierendem Sitzkern aus Polyetherschaum RG 42. Füllung Polyschaumstäbchen in bewährter Kammerkissenverarbeitung.
- C Kaltschaumkombination**
Festere Ausführung aus hochwertiger Kaltschaum-Kombination. Formstabil durch festen Polyetherkern RG 43 und angenehm weicher Kaltschaumabdeckung RG 35.
- D Taschenfederkern mit Daunencharakter**
Klassischer Sitzkomfort durch einzeln in Taschen eingenähte zylindrische Federkerne, die mit hochwertigem Kaltschaum RG 40 ummantelt sind. Legere Oberfläche durch bewährte Kammerkissen-Verarbeitung. Füllung Polyschaumstäbchen RG 40.
Aufpreis siehe Sonderanfertigungen.
- G Comfort Plus**
legere Ausführung in bewährter Stegmatten-Verarbeitung mit stabilisierendem Kern aus Kaltschaum RG 50. Füllung Polyschaumstäbchen mit hochwertigen Vliesfasern.
Aufpreis siehe Sonderanfertigungen.

Sitztiefen **Sitztiefe 53 cm**
Sitztiefe 58 cm (Mehrpreis 8 %)
Sitztiefe 62 cm (Mehrpreis 10 %)

Sitzhöhen **Sitzhöhe 43 cm**
Sitzhöhe 46 cm
Durch Verlängerung des Seitenteils ohne Aufpreis.

Bitte Sitztiefe und Sitzhöhe bei der Bestellung unbedingt angeben.

- Rückenkissen**
- A Daunencharakter**
Legere Ausführung in bewährter Kammerkissen-Verarbeitung. Füllung aus Polyschaumstäbchen und hochwertigen Vliesfasern.
- B Comfort SL**
Weiche besonders anpassungsfähige Ausführung in bewährter Kammerkissen-Verarbeitung. Füllung aus hochwertigen Vliesfaserkugeln.
- C Kaltschaum**
Formstabiler Kern aus hochwertigem Kaltschaum RG 50. Abdeckung aus Polyetherschaum RG 20 mit Vlieskaschierung.

Frame Hardwood frame in beech, plugged and glued.

Spring base Steel corrugated spring base with special covering and high-quality lining material.

Seat cushions

A Downy character
Casual looking. Proven chamber cushion with seat core stabilisation using polyether foam RG 43. Filling with small polyfoam sticks and high-quality fibres.

B Comfort SL
The nucleus of this cushion is of premium quality foam RG 42 surrounded with special cushions pockets filled with Polyfoam sticks RG 40. A combination of which provides a velvety and smooth characteristic to this cushion which is fashioned to provide supple flexibility and stability.

C Foam combination
Firmer comfort made from a high-quality cold foam combination. Dimensionally stable thanks to firm polyether core RG 43 and soft cold-foam covering RG 35.

D Pocket spring core with downy character
The foundation is made of superior quality spring core enhanced by individually sewn pockets surrounded with cold foam RG 40 which is then further finished with filling of Polyfoam sticks RG 40, thereby yielding the best in classical seating comfort.
Additional charge see Custommade extras.

G Comfort Plus
Proven, lightweight chamber design with stabilizing RG 50 cold foam core. Filled with polyether foam and high-quality non-woven fibers.
Additional charge see Custommade extras.

Seat depths **Seat depth 53 cm**
Seat depth 58 cm (Surcharge 8 %)
Seat depth 62 cm (Surcharge 10 %)

Seat heights **Seat height 43 cm**
Seat height 46 cm
By extension of the side part (without surcharge).

Important - Specify seat depth and seat height on your order.

Back cushions

A Downy character
Casual-looking. Proven chamber cushion. Filling with small polyfoam sticks and high-quality fibres.

B Comfort SL
The cushion is of premium quality with special cushions pockets filled with fibre pellets. A combination of which provides a velvety and smooth characteristic to this cushion which is fashioned to provide supple flexibility and stability.

C Cold Foam
Dimensionally stable core made from a high-quality cold foam RG 50. Covering off Polyfoam RG 20 with polyester padding.

Produktinformation / Product information Informations produits / Productinformatie

Châssis	Solide châssis en hêtre, chevillé et collé.
Suspension	Ressorts métalliques ondulés avec revêtement spécial.
Coussins de siège	<p>A Type duvet Exécution légère avec la célèbre finition alvéolée et noyau de siège stabilisateur en mousse polyéther RG 43. Rembourrage à particules de mousse polyéther et fibres textiles non tissées de haute qualité.</p> <p>B Comfort SL Exécution moelleuse particulièrement souple avec noyau de siège stabilisateur en mousse polyéther RG 42. Rembourrage à particules de mousse polyéther avec la célèbre finition alvéolée.</p> <p>C Combinaison polyéther et mousse à froid Modèle plus ferme grâce à une combinaison de polyéther et de mousse à froid de haute qualité. Noyau de mousse polyéther RG 43 indéformable, recouvert de mousse à froid RG 35 agréablement souple.</p> <p>D Ressorts ensachés avec rembourrage de type duvet Confort d'assise classique grâce aux noyaux à ressorts cylindriques ensachés séparément et enveloppés de mousse à froid RG 40 de haute qualité. Surface confortable grâce à la célèbre finition alvéolée. Rembourrage à particules de mousse polyéther RG 40. Supplément voir également exécutions spéciales.</p> <p>G Comfort Plus modèle léger à enveloppe cousue à bords courts éprouvée avec noyau stabilisateur en mousse à froid RG 50. Rembourrage avec des bâtonnets de mousse de polyéther et des fibres non tissées de haute qualité. Supplément voir également exécutions spéciales.</p>
Profondeurs d'assise	53 cm 58 cm (Supplément 8 %) 62 cm (Supplément 10 %)
Hauteur de siège	43 cm 46 cm Hauteur d'assise 46 cm en rehaussant les côtés (sans supplément). Veillez absolument indiquer la profondeurs d'assise et hauteur de siège dans votre commande.
Coussins de dossier	<p>A Type duvet Exécution légère avec la célèbre finition alvéolée. Rembourrage à particules de mousse polyéther et fibres textiles non tissées de haute qualité.</p> <p>B Comfort SL Modèle moelleuse, particulièrement souple, avec coussins à finition alvéolée. Rembourrage souple en billes de fibres polyester.</p> <p>C Mousse à froid Coussin indéformable en mousse à froid RG 50. Revêtement en mousse polyéther RG 20 avec doublure polyester.</p>

Frame	Frame uit beuk, geplugd en vastgelijmd.
Vering	Stalen springveren met speciale afwerking.
Zitkussens	<p>A Donskarakter Een losse uitvoering met de gekende kamerkussenverwerking en de stabiliserende zitkern uit polyetherschuim RG 43. Vulling van polyschuimstaafjes en hoogwaardige vliesvezels.</p> <p>B Comfort SL Zachte, zeer flexibele uitvoering met de stabiliserende zitkern uit polyetherschuim RG 42. Vulling van polyschuimstaafjes en gekende kamerkussenverwerking.</p> <p>C Koudschuimcombinatie Vastere uitvoering van hoogwaardig koudschuim. Stabiele vorm door de vaste polyetherkern RG 43 en de aangenaam zachte koudschuimbekleding RG 35.</p> <p>D Kern van pocketveren met dons karakter Klassiek zitcomfort door de in aparte pockets ingenaaide cilindervormige veerkernen die met hoogwaardig koudschuim RG 40 omwikkeld zijn. Comfortabel oppervlak door de gekende kamerkussenverwerking. Vulling polyschuimstaafjes RG 40. Meerprijs zie ook speciale uitvoeringen.</p> <p>G Comfort Plus Casual uitvoering in bewezen banenconstructie met een stabiliserende kern uit koudschuim HR 50. Vulling van polyschuimstaafjes met hoogwaardige vliesvezels. Meerprijs zie ook speciale uitvoeringen.</p>
Zitdiepte	53 cm 58 cm (Meerprijs 8 %) 62 cm (Meerprijs 10 %)
Zithoogte	43 cm 46 cm Door verlenging van de zijkant (zonder meerprijs). Vermeld bij de bestelling absoluut de zitdiepte en zithoogte.
Rugkussens	<p>A Donskarakter Een losse uitvoering in de gekende kamerkussenverwerking. Vulling van polyschuimstaafjes en hoogwaardige vliesvezels.</p> <p>B Comfort SL Zachte, zeer flexibele uitvoering in de gekende kamerkussenverwerking. Zachte vulling van hoogwaardige vliesvezeltballetjes.</p> <p>C Koudschuim Vormbestendige kern van hoogwaardig koudschuim RG 50. Afgedekt met polyetherschuim RG 20 met vliesafdekking.</p>

Produktumfang / Product range / Gamme des produits / Productomvang



910.14

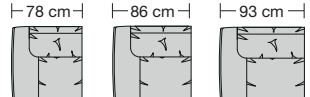

910.40 L/R 910.41 L/R 910.42 L/R

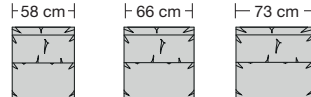

910.50 910.51 910.52

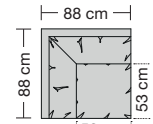

910.70

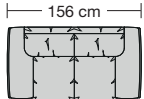

910.22

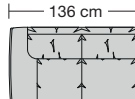

910.44 L/R

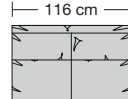

910.54

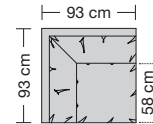

910.70 Übertief für Sitztiefe 58 cm

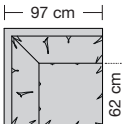

910.70 Übertief für Sitztiefe 62 cm

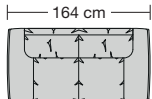

910.23

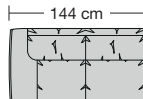

910.45 L/R

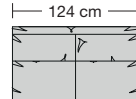

910.55

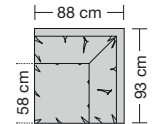

910.761 L

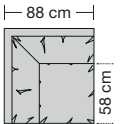

910.761 R

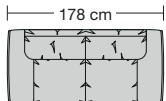

910.24

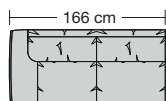

910.46 L/R

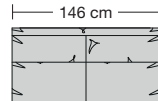

910.56

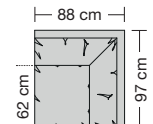

910.76 L

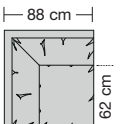

910.76 R

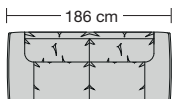

910.25

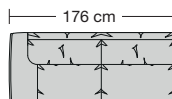

910.47 L/R

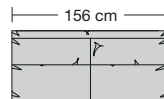

910.57

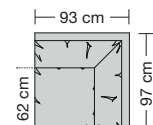

910.762 L

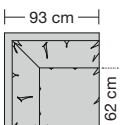

910.762 R

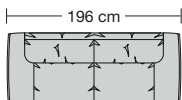

910.26

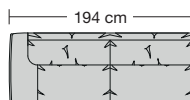

910.48 L/R

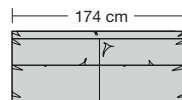

910.58

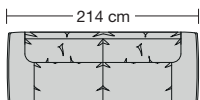

910.27

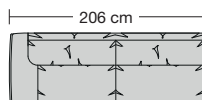

910.49 L/R

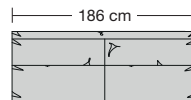

910.59

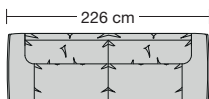

910.28

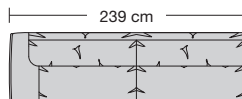

910.495 L/R

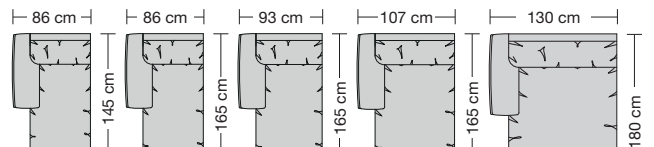

910.78 L/R 910.79 L/R 910.792 L/R 910.795 L/R 910.798 L/R

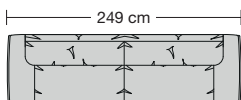

910.29

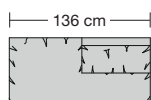

910.67 L/R

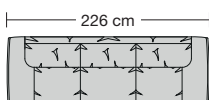

910.32

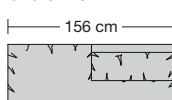

910.69 L/R

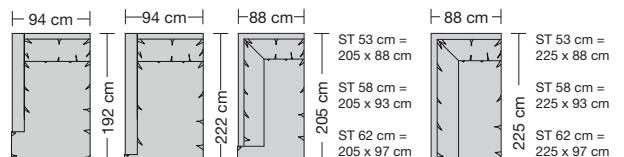

910.772 L/R 910.775 L/R 910.752 L/R 910.755 L/R

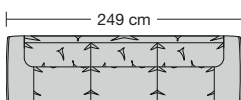

910.35

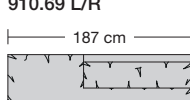

910.695 L/R

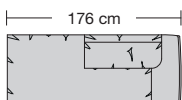

910.250 L/R

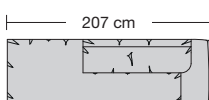

910.270 L/R

Sitztiefe, Sitzhöhe und Kissenführung bitte bei der Bestellung unbedingt angeben.

Important - Specify seat depth, seat height and seat cushion in your order.

Veuillez absolument indiquer à la commande la profondeur de siège, hauteur de siège et le modèle de coussin.

Gelieve de zitdiepte, zithoogte en kussenuitvoering bij de bestelling te vermelden.

ST 53 cm = 205 x 88 cm
ST 58 cm = 205 x 93 cm
ST 62 cm = 205 x 97 cm

ST 53 cm = 225 x 88 cm
ST 58 cm = 225 x 93 cm
ST 62 cm = 225 x 97 cm